

**SWIRL PENDANT**

SWL-23P (23")

**CAUTION**

TURN OFF THE MAIN POWER AT THE CIRCUIT BREAKER BEFORE INSTALLING THE FIXTURE IN ORDER TO PREVENT POSSIBLE SHOCK

IF YOU ARE UNFAMILIAR WITH PROPER ELECTRICAL WIRING CONNECTIONS OBTAIN THE SERVICES OF A QUALIFIED ELECTRICIAN

**GENERAL**

- Read all instructions carefully for safe operation and installation.
- All electrical connections must be in accordance with local and national electrical code (N.E.C) standards.
- Remove the fixture and the mounting package from the box and make sure that no parts are missing by referencing the illustrations on the installation instruction. Please contact Blackjack Lighting if any parts are missing or damaged.
- This product is suitable for damp locations.

**INSTALLATION**

**PREPARATION**

1. Remove the fixture from its box. You will see one 6" stem and three 12" stems(25). (This fixture can be ordered with additional 24" stems. Each fixture provides a 12' wire length to accept up to 4 additional stem sections (8 feet) for a maximum stem length of 11'6"). Select the suitable size of stems and connect them to the desired length you need to hang the fixture.
2. Put the fixture wire through the stem(25) and secure it to the threaded nipple(24) on the ball(26).
3. Remove the wiring barrier plate(13) from the ceiling plate(10) by loosening the two screws(12). (As shown in Fig.2)

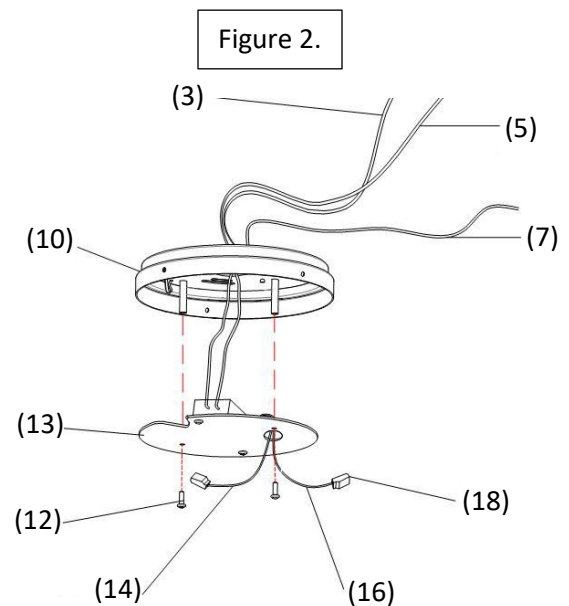
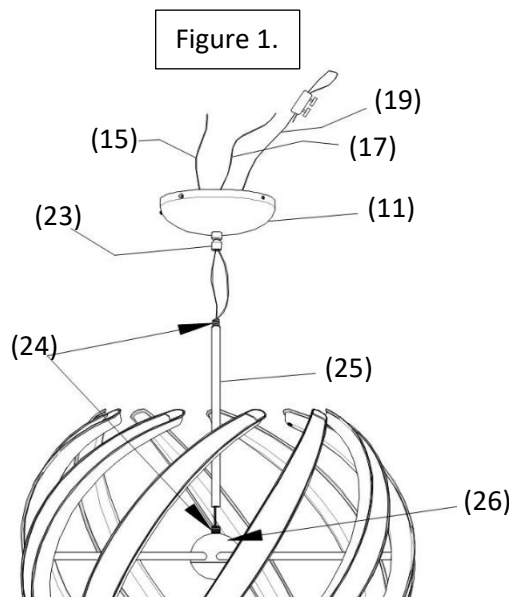

**MOUNTING**

5. Hold the ceiling plate(10) over the outlet box(1). Insert the mounting screws(9) through the slots on the ceiling plate(10). Then tightly secure the mounting screws(9) into the outlet box(1). (As shown in Fig.3) Pull the supply(2&4) and house ground(6) wires from the outlet box(1). Carefully thread them through the large center hole in the ceiling plate(10).
6. To hang the fixture, use the lifting rope(19) as a support. Attach the lifting rope(19) loop(21) to the hook(20)(secured

on the ceiling plate(10)). Install the wiring barrier plate(13) onto the ceiling plate(10) by fastening the two screws(.)(Shown in Fig.4)

### ELECTRICAL CONNECTIONS

4. Pull the white and black supply wires(2&4) and the house ground wire(6) out from the outlet box(1). Using the wire connectors(8), connect the white supply(2) wire from outlet box(1) to the white fixture wire(3); connect the black supply wire(4) from outlet box(1) to the black fixture wire(5); and connect the house ground wire(6) to the fixture ground wire(7). Carefully tuck all wires back into the outlet box(1).

Figure 3.

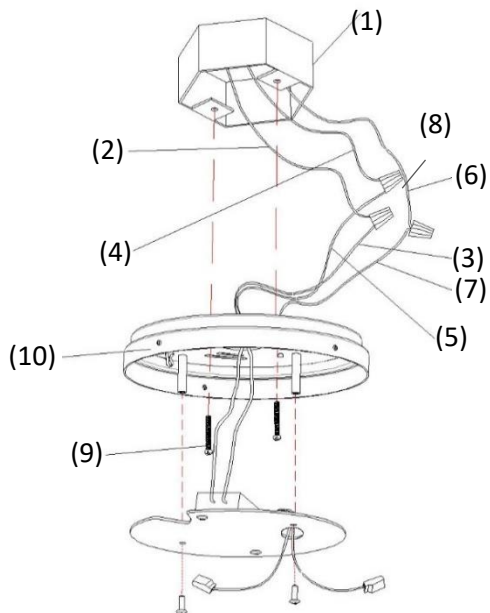
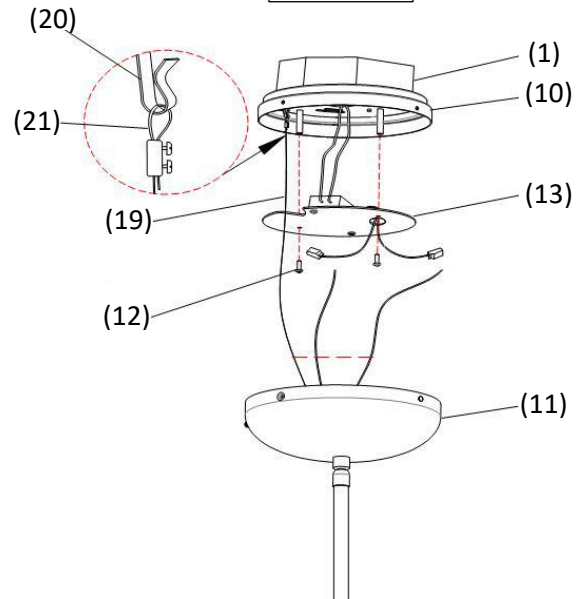

Figure 4.



### FINAL ASSEMBLY

7. Insert the red+ fixture wire(15) into the quick connectors(18) at the end of driver red+ DC out wire(14); Insert the black- fixture wire(17) into the quick connectors(18) at the end of the driver black- DC out wire(16). (As shown in Fig.5) **IMPORTANT – DO NOT CONNECT THE BLACK(-) OR THE RED(+) LOW VOLTAGE WIRES TO THE BLACK OR WHITE LINE VOLTAGE SUPPLY WIRES. THIS WILL RESULT IN SEVERE DAMAGE TO THE LIGHTING FIXTURE.**

8. Check all of the wires after they are connected. Then install the pendant fixture onto the ceiling plate(10). Lift the canopy cover(11) over the ceiling plate(10), align the holes on the sides of the canopy cover(11) with the holes of the ceiling plate(10). Then insert and tighten the three thumbscrews(22).

Figure 5.

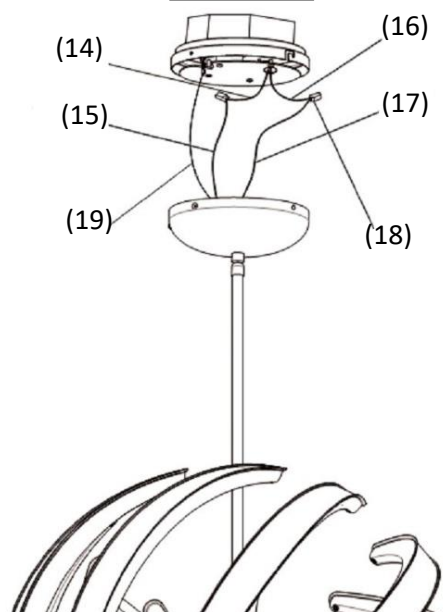
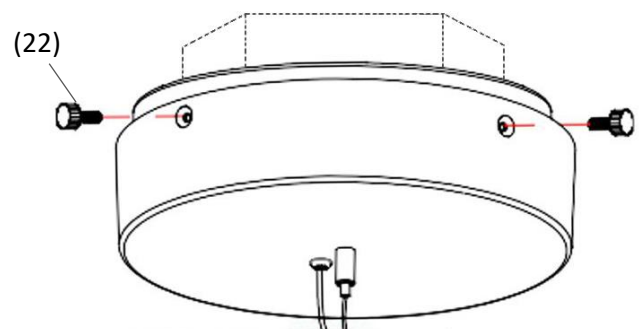

Figure 6.



## DIMMING

- Fixture Dimming Type: TRIAC dimming
- For recommended dimmers see <https://www.blackjacklighting.com/dimming-information>

## HARDWARE



**Wire Connectors(#8)**  
[ 3 Included ]



**Mounting Screw(#9)**  
[ 2 Included ]



**Screw(#12)**  
[ 2 Included ]



**Quick Connector (#18)**  
[ 2 Included ]



**Thumbscrew (#22)**  
[ 3 Included ]

1. OUTLET BOX (By others)
2. WHITE SUPPLY WIRE
3. WHITE FIXTURE WIRE
4. BLACK SUPPLY WIRE
5. BLACK FIXTURE WIRE
6. HOUSE GROUND WIRE
7. FIXTURE GROUND WIRE
8. WIRE CONNECTORS
9. MOUNTING SCREWS
10. CEILING PLATE
11. CANOPY COVER
12. SCREW
13. WIRING BARRIER PLATE
14. RED+ DC OUT WIRE
15. RED+ FIXTURE WIRE
16. BLACK- DC OUT WIRE
17. BLACK- FIXTURE WIRE
18. QUICK CONNECTOR
19. LIFTING ROPE
20. HOOK
21. LOOP
22. THUMBSCREWS
23. HANG-STRAIGHT SWIVEL
24. 1/8" THREADED NIPPLE
25. STEM
26. BALL