

**QUADRA LINEAR PENDANT**

QDR-D48 (48")

**CAUTION**

TURN OFF THE MAIN POWER AT THE CIRCUIT BREAKER BEFORE INSTALLING THE FIXTURE IN ORDER TO PREVENT POSSIBLE SHOCK

IF YOU ARE UNFAMILIAR WITH PROPER ELECTRICAL WIRING CONNECTIONS OBTAIN THE SERVICES OF A QUALIFIED ELECTRICIAN

**GENERAL**

- Read all instructions carefully for safe operation and installation.
- All electrical connections must be in accordance with local and national electrical code (N.E.C) standards.
- Remove the fixture and the mounting package from the box and make sure that no parts are missing by referencing the illustrations on the installation instruction. Please contact Blackjack Lighting if any parts are missing or damaged.
- This product is suitable for damp locations.

**INSTALLATION****PREPARATION**

1. Remove the fixture from its box.
2. Remove the ceiling plate(10) from the canopy cover(11) by loosening the two decorative nuts(12) and two thumbscrews(13).

**MOUNTING**

3. Pull the supply wires(2&4) and the house ground wire(6) out of the outlet box(1). Temporarily attach ceiling plate(10) to the outlet box(1) by using the two mounting screws(9). Mark the two mounting hole locations (for the anchor screws(14)) on the ceiling above the canopy.
4. Remove the ceiling plate(10) from the ceiling. Drill the two holes using the appropriately sized drill bit. Insert the provided ceiling anchors(15) into the holes. First screw the anchor screws(14) halfway into the ceiling anchors, then further attach the back panel(10) to the outlet box(1) by using the two mounting screws(9). Afterward fully tighten anchor screws(14).

**ELECTRICAL CONNECTIONS**

5. Using the wire connectors(8), connect the white supply wire(2) to the white fixture wire(3); connect the black supply wire(4) to the black fixture wire(5); and connect the house ground wire(6) to the fixture ground wire(7).







**FINAL ASSEMBLY**

6. Temporarily mount the canopy cover(11) to the back panel(10) by attaching both of the loops(17) to the mating hooks(16). Adjust the four suspension cables to appropriate length by either pushing the individual wire up into the adjustable gripper(18) or pushing the small barrel upward (located on the bottom of the adjustable gripper). This will release the wire tension and allow the suspended wire to increase in length.
7. Once the wire is adjusted to approximate mounting length use the attached twist ties to retain the excess wire into neat loops that will fit inside the canopy cover(11).
8. Secure the decorative pan(11) to the ceiling plate(10) by tightening the two decorative nuts(12) and the two thumbscrews(13).
9. Once the canopy(11) is in place, use the adjustable grippers(18) to fine tune the fixture suspension cable lengths so that the fixture is level and the four wires are even in length.

## DIMMING

- Fixture Dimming Type: TRIAC dimmable
- For recommended dimmers see <https://www.blackjacklighting.com/dimming-information>

## HARDWARE

- |   |   |   |  |   |   |
|---|---|---|--|---|---|
|  |  |  |  |  |  |
| <b>Wire Connectors(#8)</b><br>[ 3 Included ]                                      | <b>Mounting Screws(#9)</b><br>[ 2 Included ]                                      | <b>Decorative Nut(#12)</b><br>[ 2 Included ]                                      | <b>Thumbscrew(#13)</b><br>[ 2 Included ]   | <b>Anchor Screw(#14)</b><br>[ 2 Included ]  | <b>Anchor(#15)</b><br>[ 2 Included ]  |

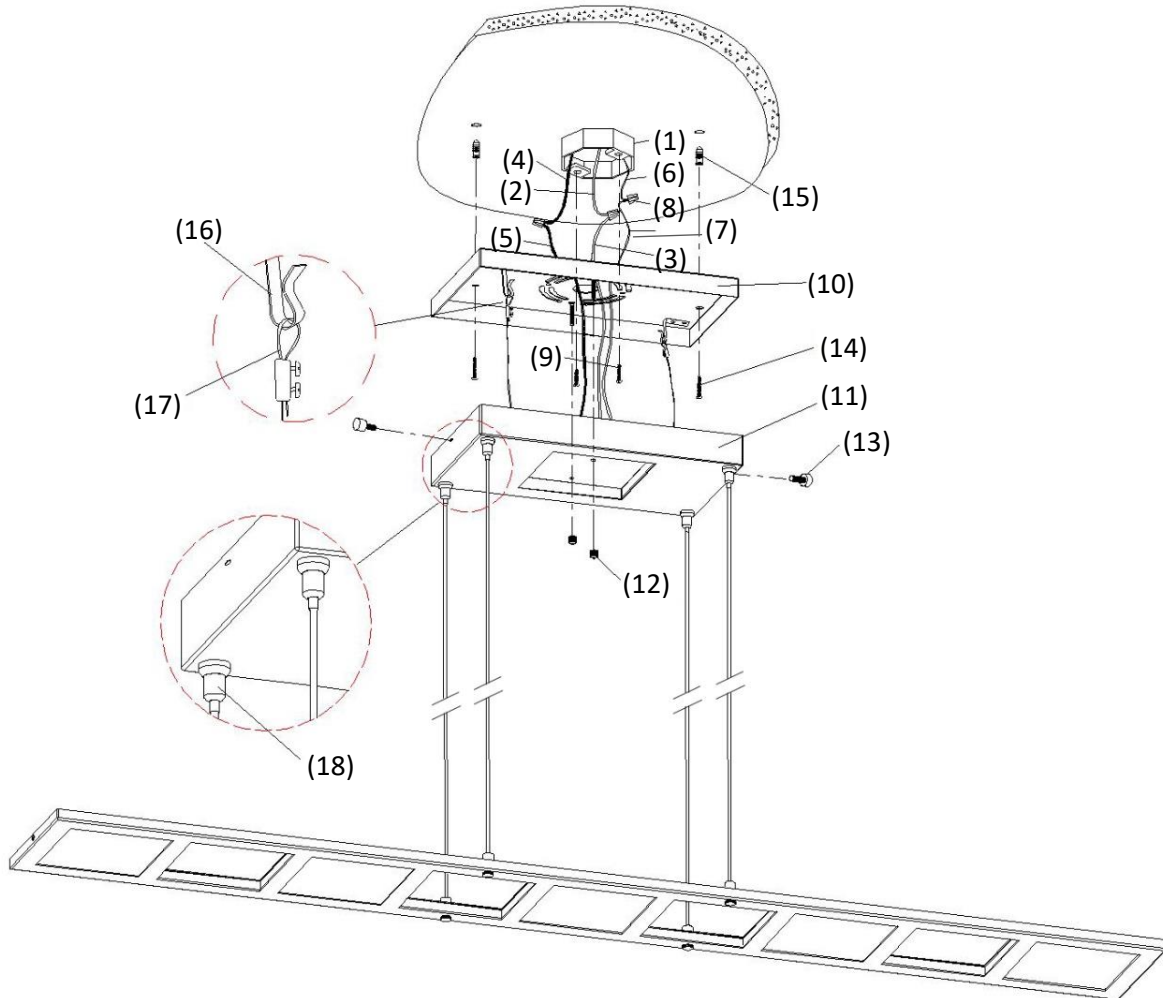

- |                           |                    |
|---------------------------|--------------------|
| 1. OUTLET BOX (by others) | 10. CEILING PLATE  |
| 2. WHITE SUPPLY WIRE      | 11. CANOPY COVER   |
| 3. WHITE FIXTURE WIRE     | 12. DECORATIVE NUT |
| 4. BLACK SUPPLY WIRE      | 13. THUMBSCREWS    |
| 5. BLACK FIXTURE WIRE     | 14. ANCHOR SCREW   |
| 6. HOUSE GROUND WIRE      | 15. ANCHOR         |
| 7. FIXTURE GROUND WIRE    | 16. HOOK           |
| 8. WIRE CONNECTORS        | 17. LOOP           |
| 9. MOUNTING SCREWS        | 18. GRIPPER        |