

Globe Pendant

MGLC-03P (3" Dia.)

CAUTION

TURN OFF THE MAIN POWER AT THE CIRCUIT BREAKER BEFORE INSTALLING THE FIXTURE IN ORDER TO PREVENT POSSIBLE SHOCK

IF YOU ARE UNFAMILIAR WITH PROPER ELECTRICAL WIRING CONNECTIONS OBTAIN THE SERVICES OF A QUALIFIED ELECTRICIAN

GENERAL

- Read all instructions carefully for safe operation and installation.
- All electrical connections must be in accordance with local and national electrical code (N.E.C) standards.
- Remove the fixture and the mounting package from the box and make sure that no parts are missing by referencing the illustrations on the installation instruction. Please contact Blackjack Lighting if any parts are missing or damaged.
- This product is suitable for damp locations.

INSTALLATION

PREPERATION

1. Carefully remove the fixture from its box.
2. Screw the globe(22) into the socket(21).
3. To remove the ceiling plate(10) from the canopy cover(11) first loosen the thumbscrew(12), then push the canopy cover(11) up and twist to the left.
4. Pull the supply wires(2&4) and the house ground wire(6) from the outlet box(1).

ELECTRICAL CONNECTIONS

5. Using the wire connectors(8), connect the white supply wire(2) to the white fixture wire(3); connect the black supply wire(4) to the black fixture wire(5); and connect the house ground wire(6) to the fixture ground wire(7) .

MOUNTING

6. Once all the wires are connected carefully wind them up and secure with the included twist ties. Then place the wires back into the outlet box(1). Secure the ceiling plate(10) to the outlet box(1) by sliding the mounting screws(9) through the holes in the ceiling plate and screwing them into the outlet box(1).

FINAL ASSEMBLY

7. Adjust the pendant cable to the desired length (if in doubt about exact length needed, leave a little extra cable until final installation of the canopy cover(11)). Push the excess cable up into the canopy by pressing the small barrel of the gripper(18) upward. This will release the cable tension and allow the suspended cable to be pulled through gripper(18). Roll the excess cable into a small loop inside the canopy. Wrap the supplied Velcro strap around this loop to keep the excess cable from falling outside of it. Then attach low voltage power feed by plugging in the female connector(16) from the driver to the male connector from the pendant cable(19). Secure the wiring barrier plate(14) to the canopy cover(11) with the included screws(17).
8. Secure the canopy cover(11) to the ceiling plate(10) by first aligning the canopy(11) cut outs with the ceiling plate(10) tabs then pushing the canopy cover(11) up over the ceiling plate(10) and twisting to the right. Lastly secure them together with the thumbscrew(12).

DIMMING

- Fixture Dimming Type: TRIAC or ELV dimming.
- For recommended dimmers see <https://www.blackjacklighting.com/dimming-information>

HARDWARE

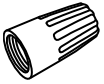

Wire Nut (#8)
[3 Included]



Mounting Screw (#9)
[2 Included]



Thumbscrew (#12)
[1 Included]



Screws (#17)
[2 Included]

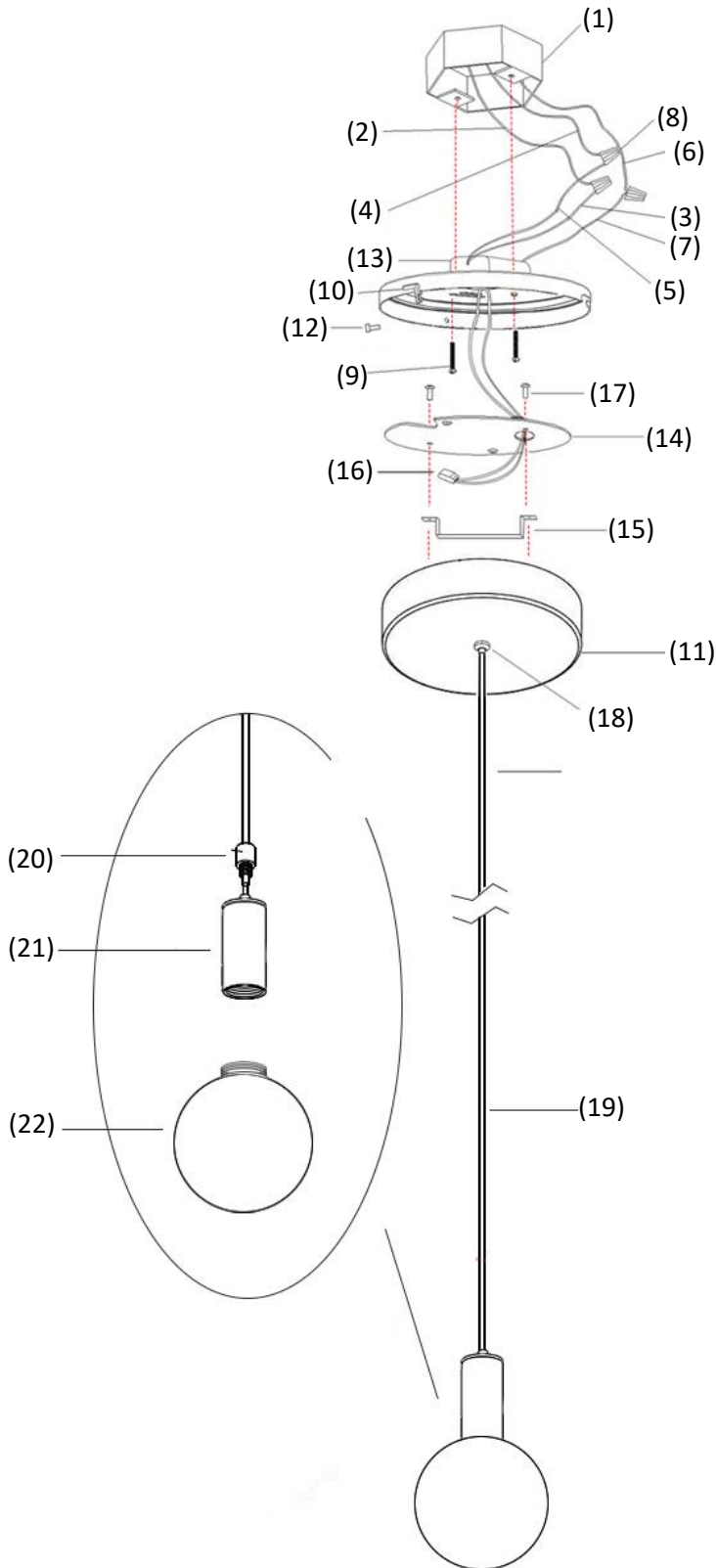

1. OUTLET BOX (By others)
2. WHITE SUPPLY WIRE
3. WHITE FIXTURE WIRE
4. BLACK SUPPLY WIRE
5. BLACK FIXTURE WIRE
6. HOUSE GROUND WIRE
7. FIXTURE GROUND WIRE
8. WIRE CONNECTORS
9. MOUNTING SCREWS
10. CEILING PLATE
11. CANOPY COVER
12. THUMBSCREW
13. DRIVER
14. WIRE BARRIER PLATE
15. U-BRACKET
16. FEMALE CONNECTOR
17. SCREWS
18. GRIPPER
19. CABLE
20. LIGHT GUIDE GRIPPER
21. SOCKET
22. LIGHT GUIDE