

**CUBE VANITY**

CUB-24V (24")

**CAUTION**

TURN OFF THE MAIN POWER AT THE CIRCUIT BREAKER BEFORE INSTALLING THE FIXTURE IN ORDER TO PREVENT POSSIBLE SHOCK

IF YOU ARE UNFAMILIAR WITH PROPER ELECTRICAL WIRING CONNECTIONS OBTAIN THE SERVICES OF A QUALIFIED ELECTRICIAN

**GENERAL**

- Read all instructions carefully for safe operation and installation.
- All electrical connections must be in accordance with local and national electrical code (N.E.C) standards.
- Remove the fixture and the mounting package from the box and make sure that no parts are missing by referencing the illustrations on the installation instruction. Please contact Blackjack Lighting if any parts are missing or damaged.
- This product is suitable for damp locations.

**INSTALLATION****PREPARATION**

1. Remove the fixture from its box.
2. Remove the decorative plate/ acrylic lens assembly(15/ 16) from the fixture pan(11) by loosening the two screws(14). Retain the screws.

**MOUNTING**

3. Remove the back panel(10) from the fixture pan(11) by loosening the four screws(12)
4. Pull the supply wires(2&4) and the house ground wire(6) out of the outlet box(1). Install the cross bar(18) to the outlet box(1) by using the two mounting screws(9).
5. Place the back panel(10) over the cross bar(18) through the two outward screws(17) and secure it by tightening the two hex nuts(13).

**ELECTRICAL CONNECTIONS**

6. Using the wire connectors(8), connect the white supply wire(2) to the white fixture wire(3); connect the black supply wire(4) to the black fixture wire(5); and connect the house ground wire(6) to the fixture ground wire(7).

**FINAL ASSEMBLY**

7. Align the four holes on the fixture pan(11) with the four screws(12). Tighten the screws(12) to secure the fixture pan(11) to the back panel(10).
8. Before assembling the decorative plate/ acrylic lens assembly(15 / 16), insert both of the screws(14) into the threaded raised tabs on the decorative plate(15). Thread the screws(14) into the tabs so the ends do not extend beyond the back of the tabs.
9. Insert the two tabs from the inside of the decorative plate(15) into the two rectangular slots on the side of the fixture pan(11). (Please see fig.2)
10. Rotate the other side of the decorative plate(15) up until the screws(14) are aligned with the mounting holes in the fixture pan(11). Now thread the two screws(14) completely into the fixture pan(11).
11. If the diffuser surface requires cleaning, we recommend using NOVUS 7020 plastic polish #1

## DIMMING

- Fixture Dimming Type: 120V / TRIAC dimming
- For recommended dimmers see <https://www.blackjacklighting.com/dimming-information>

## HARDWARE



**Wire Connectors (#8)**  
[ 3 Included ]



**Mounting Screws (#9)**  
[ 2 Included ]



**Screws (#12 and #14)**  
[ 6 Included ]



**Hex Nut (#13)**  
[ 2 Included ]



**Outward Screw (#17)**  
[ 2 Included ]

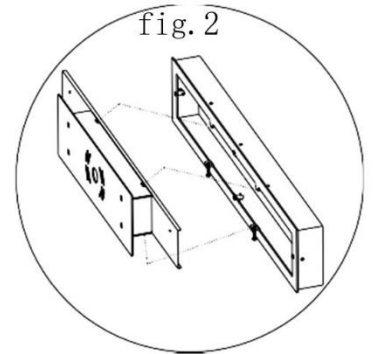
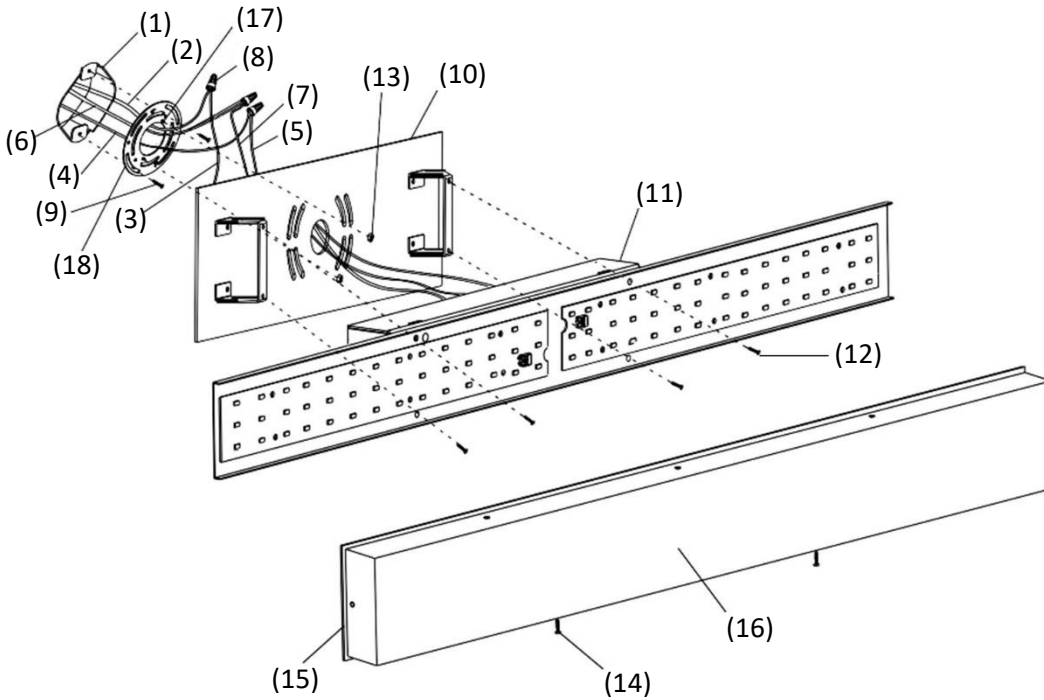

- |                           |                      |
|---------------------------|----------------------|
| 1. OUTLET BOX (by others) | 10. BACK PANEL       |
| 2. WHITE SUPPLY WIRE      | 11. FIXTURE PAN      |
| 3. WHITE FIXTURE WIRE     | 12. SCREWS           |
| 4. BLACK SUPPLY WIRE      | 13. HEX NUT          |
| 5. BLACK FIXTURE WIRE     | 14. SCREWS           |
| 6. HOUSE GROUND WIRE      | 15. DECORATIVE PLATE |
| 7. FIXTURE GROUND WIRE    | 16. ACRYLIC LENS     |
| 8. WIRE CONNECTORS        | 17. OUTWARD SCREW    |
| 9. MOUNTING SCREWS        | 18. CROSS BAR        |